

Die Holzmuster, Holzwerkstoffe und Objekte (mit Ausnahme der Materialien für den Fassadenturm und die Musterkiste) wurden zur Verfügung gestellt von:

Michael Murauer
Marco Petz
Georg Riesenhuber
J. u. A. Frischeis GmbH
Tischlerei Marcell GmbH



Nr. 1
Fassadenturm

MATERIALSPONSORING

Schrauben
SIHAG GMBH, Ohlsdorf bei Gmunden
Ing. Michael Palfi, MAS

Holzbretter
Holzbau Wallner GmbH, Feistritz an der Gail
Holz Granitzer, Lieserbrücke



Nr. 2
Musterkiste



Nr. 3
Apfelbaum (wird noch geschnitten)
ca. 80 Jahre alt

Nr. 4
Balken, Bauernhaus



Nr. 5
Zaunpfahl





Nr. 6
Zaunpfahl



Nr. 7
Birke



Nr. 8
Buche



Nr. 9
Fichte



Nr. 10
Nordmann-Tanne



Nr. 11
Birkenbaum



Nr. 12
Skulptur Birnen Brennholz



Nr. 13
Edelkastanie



Nr. 14
Lärche



Nr. 15
Lärchenschindel

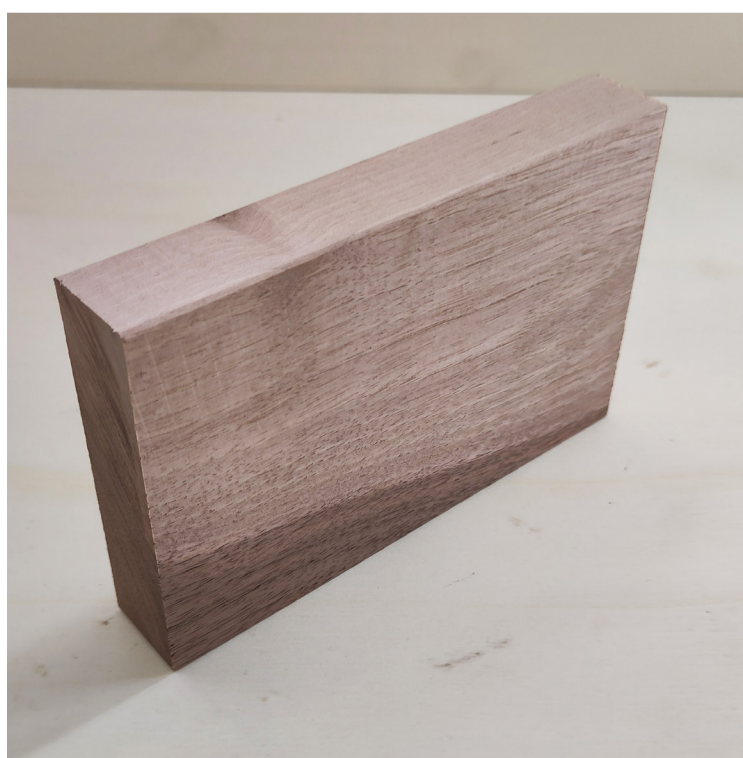

Nr. 16
Holz



Nr. 17
Holz



Nr. 18
Weide



Nr. 19
Birke



Nr. 20
Esche



Nr. 21
Holz

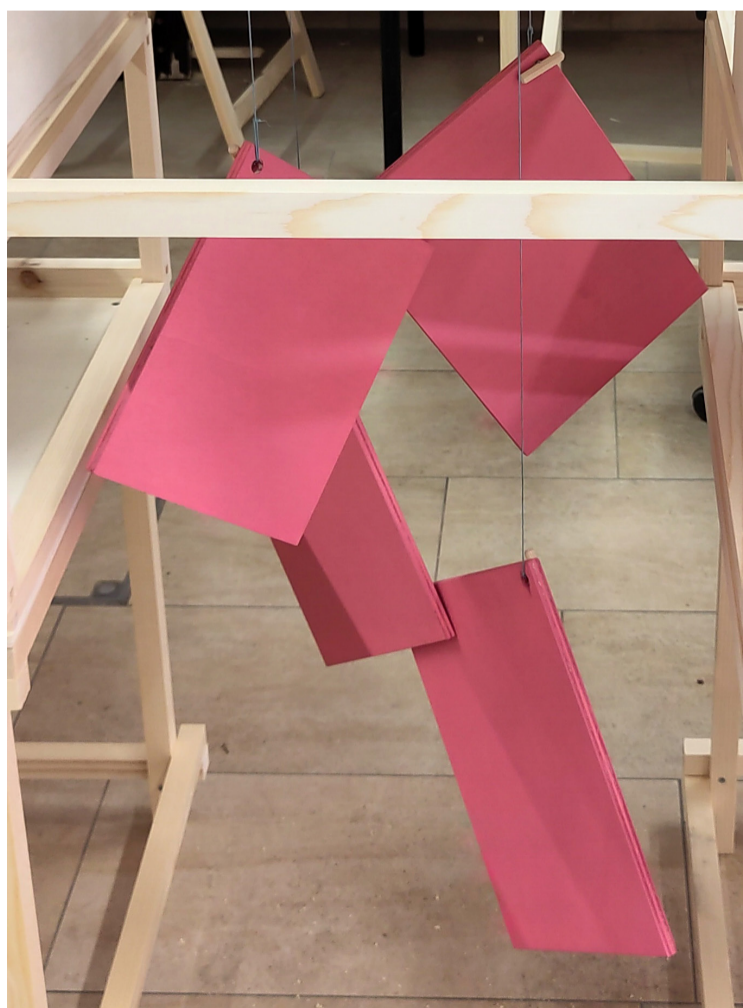

Nr. 22
Zeichenunterlage, Klemmbrett
4 Stück

Nr. 23
Brandversuch



Nr. 24
Brandversuch





Nr. 25
Bahnschwelle



Nr. 26
Buchsbaum



Nr. 27
Buchsbaum



Nr. 28
Holz



Nr. 29
Holzbox - Nussholz
Schlegel - Buche - 4 St



Nr. 30
Xylophon
unterschiedliche Holzarten



Nr. 31
Xylophon
Ahorn - verschiedene Längen

Nr. 32
Holzwerkstoffe
8 Stück

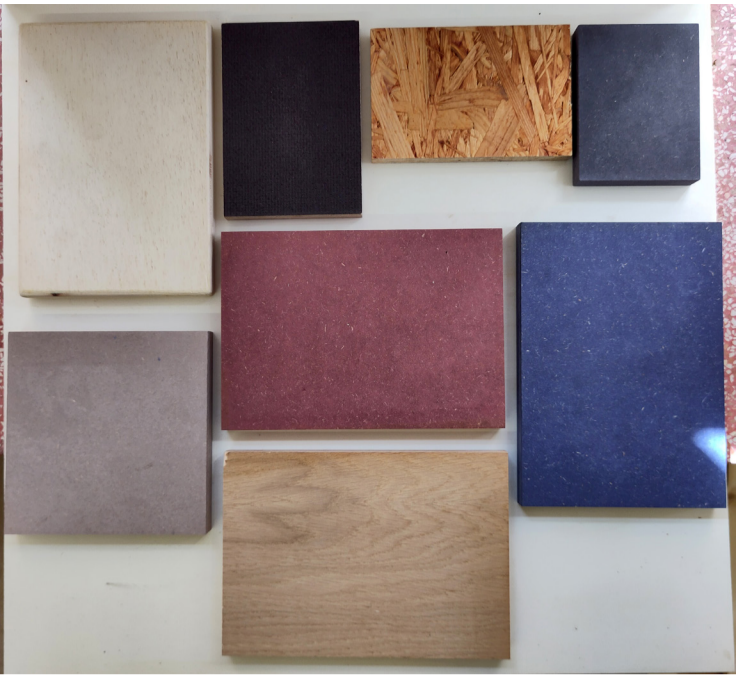

Nr. 33
Holzwerkstoffe
3 Stück



LifeLongWood

wood library - ShareWood

travelling exhibition - WanderWood

exhibition structure - modules - dimensions

20.08.2025

The modules are connected with 4 cm long wooden pins.

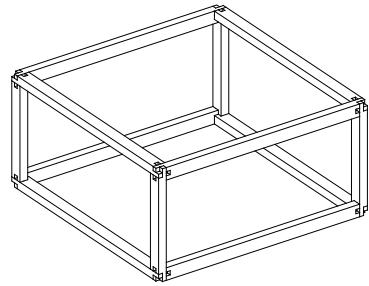

13 pieces
exhibition module

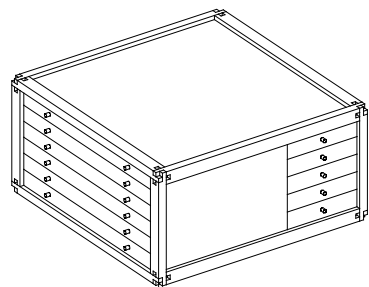

2 pieces
module with drawers

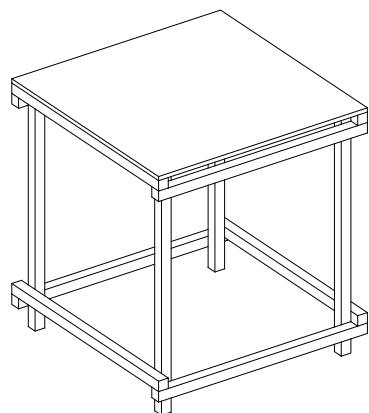

6 pieces
exhibition pedestal

facade collage tower
5 modules (80x80x43 cm)
that are stacked
on top of each other

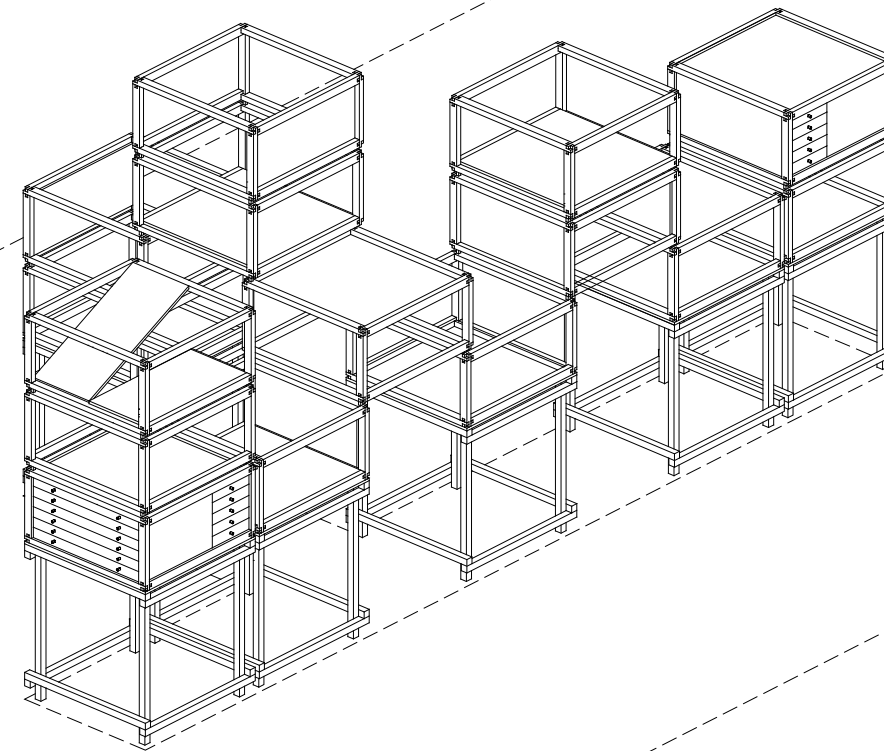
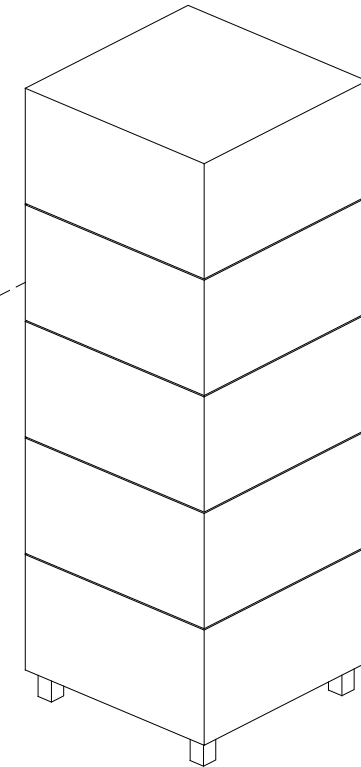

Interreg



Sofinancira
EVROPSKA UNIJA
Kofinanciert von
der EUROPÄISCHEN UNION

Slovenija – Österreich

LifeLongWood

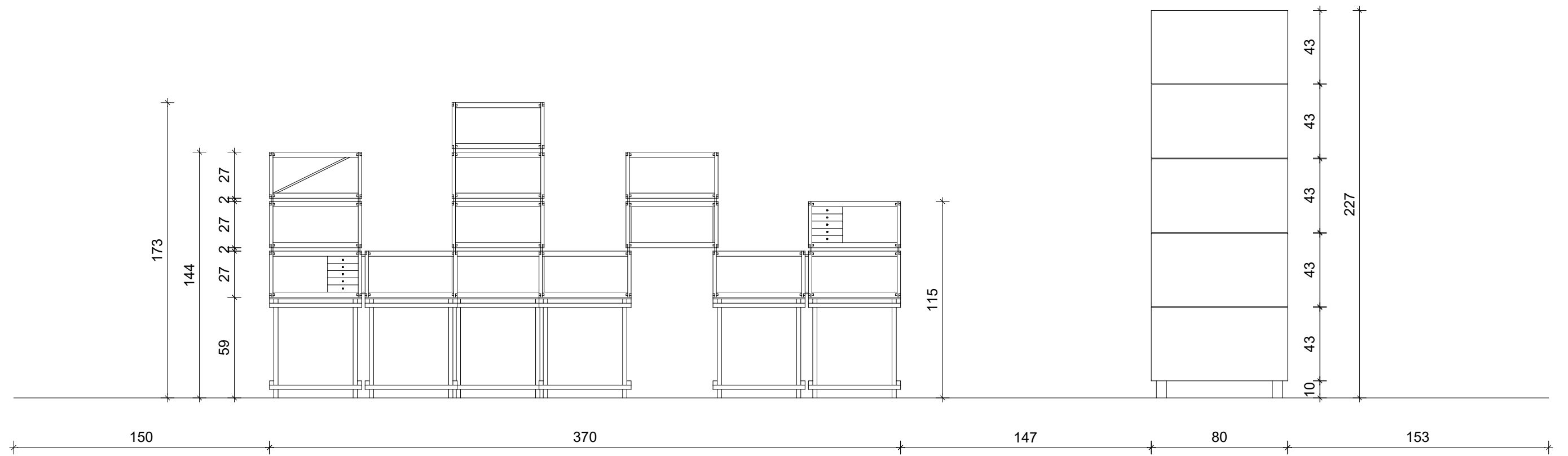

LifeLongWood
 wood library - ShareWood + travelling exhibition - WanderWood
 elevation - sheet size DIN A3
 20.08.2025

